

# ARGO LIBRO T

## 286T Round / 286T Elliptical



### DESCRIPTION / DESCRIZIONE

**en** Argo Libro T is a space saving table that can be fold in 40 cm and offers a wide and safe work surface. Designed to be equipped with round or elliptical tops it can be used during meetings, coworking and hospitality events whilst giving the spaces a great usage flexibility. The mechanical folding system allows one person only to easily open the table. Once closed it can be troubleless moved through doors and elevators as well as stored in small spaces.

The table is equipped with the exclusive antishock system, designed and patented by Mara, which is able to keep the user's hands safe when opening the table.

**it** Argo Libro Tondo è un tavolo salvaspazio richiudibile in soli 40 cm che offre una superficie d'appoggio larga e robusta. Ideato per montare piani tondi o ellittici, può essere usato per riunioni, lavori di gruppo, banchetti e buffet, dando agli spazi un'ampia flessibilità d'utilizzo. Il sistema di chiusura meccanico rende questo tavolo facilmente manovrabile da una persona sola. Una volta richiuso passa con facilità da porte e ascensori e può essere riposto anche in piccoli ambienti.

Argo Libro Tondo è dotato dell'esclusivo sistema antishock brevettato Mara, in grado di tenere in sicurezza le mani dell'utilizzatore durante l'apertura.

ARGO LIBRO TONDO  
folding table on castors  
tavolo pieghevole su ruote

#### 286T Round

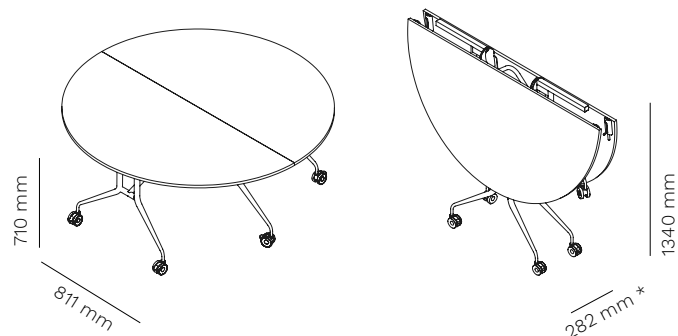

top  
Round: Ø 1600/1800 mm

\* with tops: min 284 mm - max 292 mm

#### 286T Elliptical

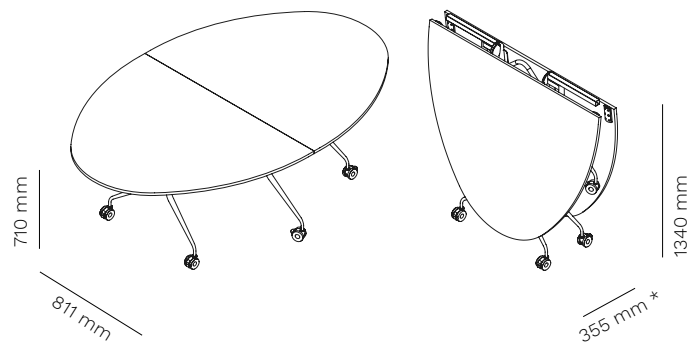

top  
Elliptical: 1500 x 2400 mm

\* with tops: min 360 mm - max 365 mm



**patented system**  
sistema brevettato



**stackable**  
impilabile



**frame delivered assembled**  
telaio fornito montato



**version with FSC® certified top**  
versione con piano certificato FSC®



**39 Kg**



**1 pc**  
1,02 mc



**2 pcs / EU pallet**  
110 x 150 cm pallet

<b>1 FRAME</b> 1 TELAIO	<b>39 Kg</b>	<b>1 pc</b> 1,02 mc	<b>2 pcs / EU pallet</b> 110 x 150 cm pallet
----------------------------	--------------	------------------------	---

**ARGO LIBRO T**  
286T Round / 286T Elliptical

**mara**<sup>®</sup>

**INCLUDED ACCESSORIES / ACCESSORI INCLUSI**



**antishock system**  
sistema antishock



**locking system and tops alignment**  
sistema di chiusura e allineamento piani

**K075**



**kit of 4 castors Ø 75 mm with integrated brakes**  
kit 4 ruote Ø 75 mm con freni integrati

**ACCESSORIES / ACCESSORI**

**511PLUS**



**top access with flip cover**  
passacavi con sportello

**511EPLUS**



**top access with multifunctional sockets**  
passacavi con prese multifunzione

**PASD60**



**multifunctional sockets Ø 60 mm**  
prese multifunzione Ø 60 mm

**PASD80**



**multifunctional sockets with wireless charging Ø 80 mm**  
prese multifunzione con ricarica wireless Ø 80 mm

**350P**



**plastic cables-fixer for table top**  
portacavi in plastica per piano

**500DROLL**



**mobile storage system, on castors**  
cassettiera mobile su ruote

**300**



**cpu holder**  
portaserver

**K100 \***



**kit of 4 castors Ø 100 mm with integrated brakes**  
kit 4 ruote Ø 100 mm con freni integrati

**\* the table will be 25 mm higher**

**\* il tavolo si alzerà di 25 mm**

# ARGO LIBRO T

286T Round / 286T Elliptical

# mara®

## FRAME / STRUTTURA

**powder coated steel**  
acciaio verniciato

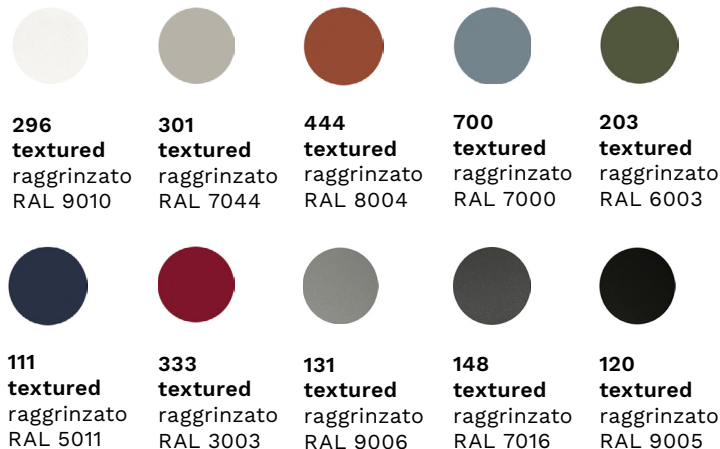

**chromed steel**  
acciaio cromato



**eco chrome**  
cromo ecologico

## TOP / PIANO

**standard FENIX tops**  
piani standard in FENIX



**STANDARDS AND CERTIFICATES / NORME E CERTIFICATI**  
Resistance to scratching EN 438-2:2019 - CL.25 Class  $\geq 4$  •  
Resistance to staining EN 438-2:2019 - CL.26 Group 1 e 2: Class 5 Group 3: Class  $\geq 4$  • Resistance to dry heat (160°C/20') - EN 438-2:2019 - CL.16 Class 5 • Lightfastness (xenon arc) EN 438-2:2019 - CL.27 Grayscale classification  $\geq 4$  • Resistance to steam

EN 438-2:2019 - CL.14 Class 5 • Specular surface reflection ISO 2813 8 ÷ 16 a 85° Unità Gloss • Resistance to surface wear EN 438-2:2019 - CL.10 Rotation value IP  $\geq 200$  • Resistance to damp heat (100°C/20') - EN 438-2:2019 - CL.18 Class 5

**TOP / PIANO**

**standard colour and material effect laminate tops**

piani standard in laminato colore ed effetto materico



**white**  
bianco



**magnolia**



**light grey**  
grigio  
chiaro



**anthracite**  
antracite



**black**  
nero



**white marble**  
marmo  
bianco



**grey marble**  
marmo  
grigio



**graphite marble**  
marmo  
grafite



**black marble**  
marmo  
nero



**whitened oak**  
rovere  
sbiancato



**natural oak**  
rovere  
naturale



**grey oak**  
rovere  
grigio



**black oak**  
rovere  
nero



**walnut**  
noce



**rose**  
rose



**yellow**  
giallo



**light blue**  
azzurro



**green**  
verde

**STANDARDS AND CERTIFICATES / NORME E CERTIFICATI**

Dimensional tolerance related to the thickness  $\pm 0,3$  mm • Dimensional tolerance related to the sizes  $\pm 5,0$  mm • Resistance to scratching EN 438-2:2016 Class 3 • Resistance to staining EN 438-2:2016 Group 1 e 2: Class  $\geq 4$  Group 3: Class  $\geq 4$  • Resistance to dry heat (160°C/20') - EN 438-2 Class 4 • Lightfastness (xenon arc) EN 438-2 Grayscale classification  $\geq 4$

• Resistance to steam EN 438-2 Class 4 • Resistance to surface wear EN 438-2 Rotation value IP  $\geq 150$  • Resistance to damp heat (100°C/20') - EN 438-2 Class 4

**standard colour and wood melamine tops**

piani standard in nobilitato colore e legno



**white**  
bianco



**magnolia**



**light grey**  
grigio  
chiaro



**anthracite**  
antracite



**black**  
nero



**whitened oak**  
rovere  
sbiancato



**natural oak**  
rovere  
naturale



**grey oak**  
rovere  
grigio



**black oak**  
rovere  
nero



**walnut**  
noce

**STANDARDS AND CERTIFICATES / NORME E CERTIFICATI**

Dimensional tolerance related to the sizes  $\pm 5,0$  mm • Resistance to scratching 1,5 N • Resistance to cigarette burning 3 grade - moderate change in gloss level and/or moderate brown spots • Resistance to surface wear Rotation value IP  $< 50$  Rotation value WR  $< 150$  • Risk of breakage  $\geq 3$  group • Dimensional tolerance related to the thickness  $15 \leq X \leq 20$  mm :  $\pm 0,3$  mm  $X < 20$  mm :  $\pm 0,5$  mm • Resistance to staining  $\geq 3$  group

• Resistance to steam 4 grade - moderate change in gloss level and/or color • Surface imperfections Prolate imperfections:  $< 20$  mm/m Punctiform imperfections:  $< 2$  mm<sup>2</sup>/m<sup>2</sup> • Lightfastness (xenon arc)  $> 6$  group

**CLEANING AND MAINTENANCE / PULIZIA E MANUTENZIONE**

**STEEL / ACCIAIO**

**en** Our types of metals include: chromed metals and painted metals. Do not use acid or alkaline based cleaning products. Do not use detergents, steel wool, dishwashing detergents or the like. Sharp or pointed objects may damage the surface. Any hot or wet object may cause surface damage. Clean the surface regularly with a soft cloth to remove dust. To remove light dirt, use a soft cloth and a neutral household cleaner.

**it** Le nostre tipologie di metallo comprendono: metalli cromati e metalli verniciati. Non utilizzare prodotti per la pulizia a base acida o alcalina. Non utilizzare detergenti, lana di acciaio, detersivi per stoviglie o simili. Oggetti appuntiti o taglienti possono danneggiare la superficie. Qualsiasi oggetto caldo o bagnato potrebbe provocare danni alla superficie. Pulire la superficie regolarmente con un panno soffice per rimuovere la polvere. Per rimuovere lo sporco leggero utilizzare un panno soffice e un prodotto per le pulizie di casa neutro.

**CHROMED STEEL AND ALUMINIUM POLISHED / ACCIAIO CROMATO E ALLUMINIO LUCIDO**

**en** Do not use acid or alkaline based cleaning products. Do not use detergents, steel wool, dishwashing detergents or the like. Sharp or pointed objects may damage the surface. Any hot or wet object may cause surface damage. Clean the surface regularly with a soft cloth to remove dust. To remove light dirt, use a soft cloth and a neutral household cleaner

**it** Non utilizzare prodotti per la pulizia a base acida o alcalina. Non utilizzare detergenti, lana di acciaio, detersivi per stoviglie o simili. Oggetti appuntiti o taglienti possono danneggiare la superficie. Qualsiasi oggetto caldo o bagnato potrebbe provocare danni alla superficie. Pulire la superficie regolarmente con un panno soffice per rimuovere la polvere. Per rimuovere lo sporco leggero utilizzare un panno soffice e un prodotto per le pulizie di casa neutro.

**LAMINATE AND MELAMINE / LAMINATI E NOBILITATI**

**en** Laminates and melamine products guarantee high performance in terms of resistance to scratches, shocks and abrasions. Keep furniture away from direct sunlight; furniture in direct sunlight may tend to discolour over time. Do not use acid or alkaline based cleaning products. Sharp or pointed objects can damage the surface. Laminate and melamine furniture can be cleaned using a mixture of liquid soap and hot water. Rinse with cold water and dry with a paper towel or damp cloth.

**it** Laminati e nobilitati garantiscono alte prestazioni di resistenza ai graffi, agli urti e alle abrasioni. Mantenere i mobili lontani dalla luce diretta del sole; i mobili che si trovano alla luce diretta del sole potrebbero tendere a scolorire nel tempo. Non utilizzare prodotti per la pulizia a base acida o alcalina. Oggetti appuntiti o taglienti possono danneggiare la superficie. E' possibile effettuare la pulizia dei mobili in laminato e nobilitato usando una miscela di sapone liquido e acqua calda. Sciacquare con acqua fredda e asciugare con un tovagliolo di carta o un panno umido.

**STANDARD FENIX TOPS / PIANI STANDARD IN FENIX**

**en** Cleaning FENIX means cleaning its structure. You can do this with warm water. As FENIX is a strong material, you can also use any household cleaner – even solvents like acetone \* if needed. However, to avoid damaging the structure, don't scrub it with abrasive cream, a scouring pad or a hard brush; in the long-term, this might lead to a glossy spot on your matt surface. Instead, you can use a melamine sponge – also known as a magic sponge. As a final step, to avoid anything staying behind in the structure – whether that's dirt or residue from your cleaner – always rinse afterward with warm water and wipe dry with a clean cloth.

\* always follow safety instructions

**it** Pulire FENIX significa pulirne la struttura. Si può farlo, usando acqua tiepida. Poiché FENIX è un materiale resistente, si può utilizzare qualsiasi detergente per la casa, se necessario anche un solvente come l'acetone \*. Tuttavia, per evitare di danneggiare la struttura, è consigliabile evitare di strofinarla usando una crema abrasiva, una spugna abrasiva o una spazzola con setole dure; nel tempo, ciò potrebbe portare alla formazione di un'area lucida sulla superficie opaca. Si può piuttosto utilizzare una spugna in melamina, nota anche come spugna magica. Come ultimo passaggio, per evitare la formazione di depositi nella struttura, che si tratti di sporco o residui del detergente, risciacquare sempre con acqua tiepida e asciugare con un panno pulito.

\* seguire sempre le istruzioni di sicurezza.

# TOP ACCESS

PASSACAVI

511PLUS

# mara®

## DESCRIPTION / DESCRIZIONE

**en Aluminium top access with flap. Black brush.**

**it Passacavi in alluminio con spazzola nera.**



1

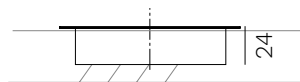
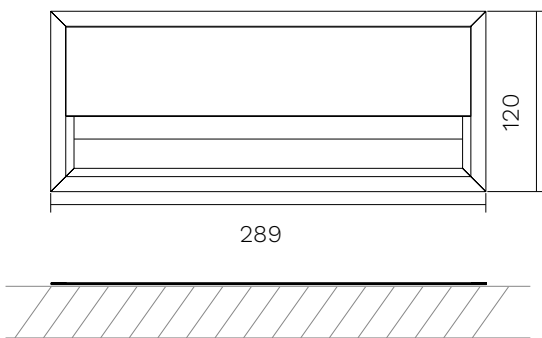

**All measurements are indicated in mm**  
Tutte le misure sono indicate in mm

### Surface cut-out area

Area di taglio della superficie

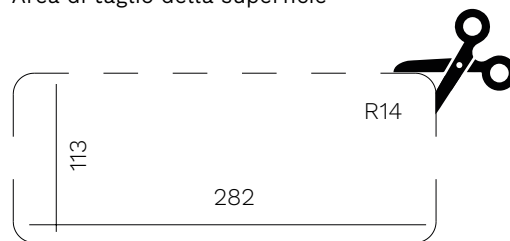

## COLOURS AVAILABLE / COLORI DISPONIBILI

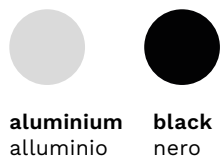

**aluminium**  
alluminio

**black**  
nero



**TOP ACCESS WITH INTEGRATED POWER UNIT**  
**PASSACAVI CON MULTIPRESA INTEGRATA**

**mara**<sup>®</sup>

511EPLUS

**DESCRIPTION / DESCRIZIONE**

**en** Top access with integrated power unit for table tops max 30 mm thick, available in aluminium or black colour, 289x120 mm with 2 mt. power cable + 2 DE sockets + 2 USB 5V/2, 4A + 2 RJ45 sockets.

**it** Passacavo con multipresa integrata per piani tavoli spessore max 30 mm, disponibile nei colori alluminio o nero, 289x120 mm con 2 mt. di cavo di alimentazione + 2 presa DE + 2 prese USB 5V/2, 4A + 2 prese RJ45.



**Optional (on demand)\*:**  
 Opzionali (su richiesta)\*:



\* dedicated quotation / quotazione dedicata

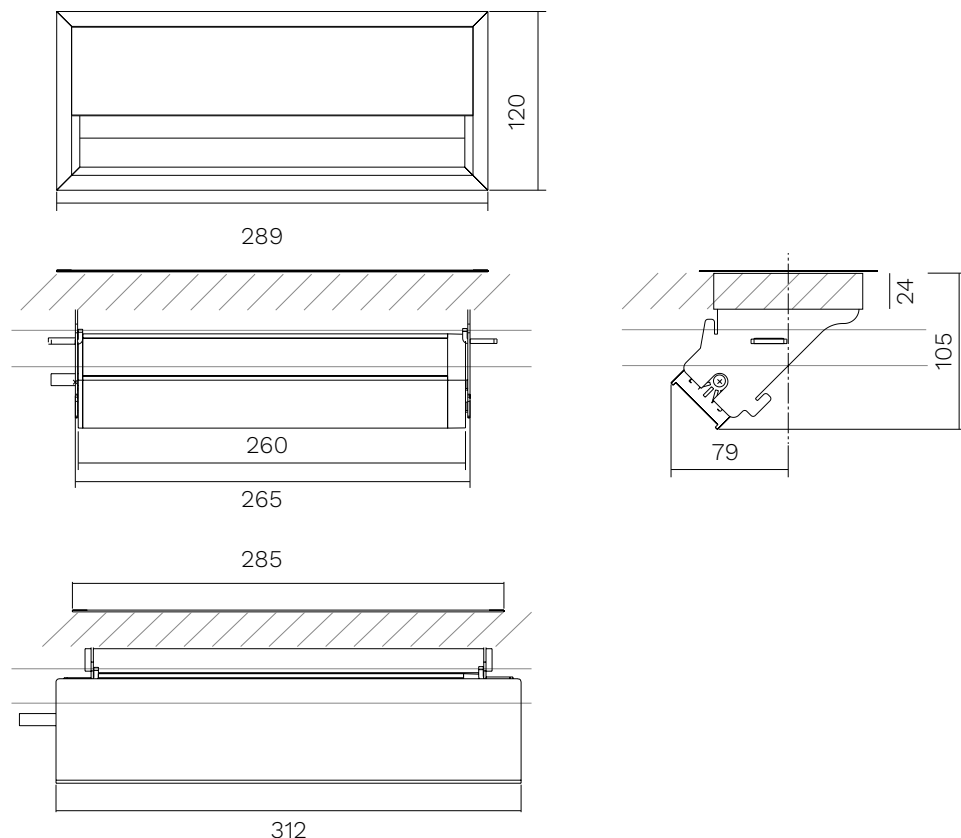

All measurements are indicated in mm  
 Tutte le misure sono indicate in mm

**COLOURS AVAILABLE / COLORI DISPONIBILI**

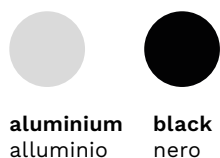

# TOP ACCESS WITH INTEGRATED MULTIFUNCTIONAL SOCKET

PASSACAVI CON MULTIPRESA INTEGRATA

PASD60

# mara®

## DESCRIPTION / DESCRIZIONE

**en** Top access round with integrated multifunctional socket for table tops, available in white or black colours, diameter 60 mm with 1,5 mt. power cable + 1 DE + 1 USB 5V/2, 4A socket.

**it** Presa multifunzione rotonda per piani tavoli, disponibile nei colori bianco o nero, diametro 60 mm con 1,5 mt. di cavo di alimentazione + 1 presa DE + 1 presa USB 5V/2, 4A.



**Optional (on demand)\*:**  
Opzionali (su richiesta)\*:

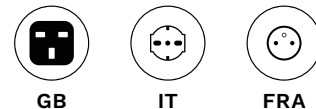

\* dedicated quotation / quotazione dedicata

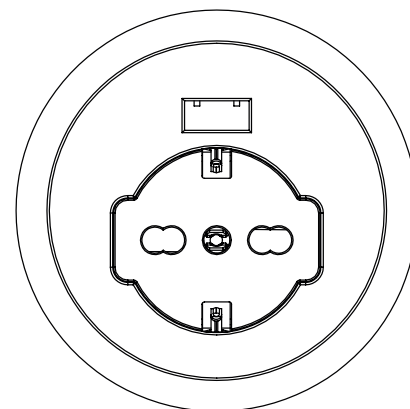
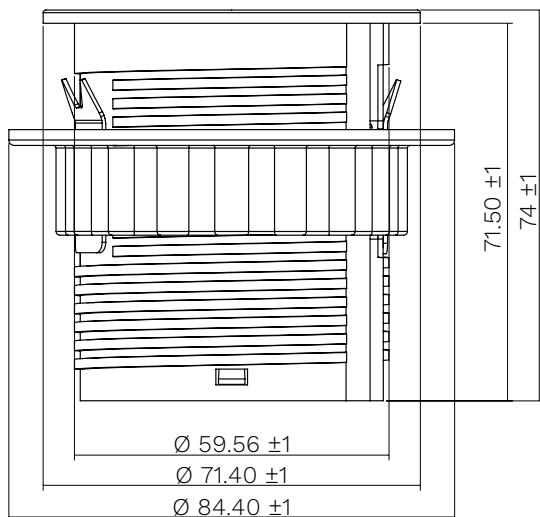

**Surface cut-out area**

Area di taglio della superficie

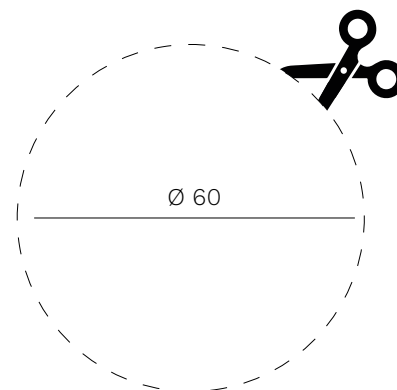

All measurements are indicated in mm  
Tutte le misure sono indicate in mm

## COLOURS AVAILABLE / COLORI DISPONIBILI



white  
bianco



black  
nero





**CABLE MANAGEMENT WITH INTEGRATED MULTISOCKET**  
**PASSACAPO CON MULTIPRESA INTEGRATA**



PASD80

**DESCRIPTION / DESCRIZIONE**

**en** Top access round with integrated multifunctional socket for table tops, available in white or black colours, diameter 80 mm with 2 mt. power cable + 1 DE + 2 USB 5V/2, 4A socket + 1 RJ45 (interchangeable). The inside of the cover is equipped with a wireless charger (usable only when open).

**it** Presa multifunzione rotonda per piani tavoli, disponibile nei colori bianco o nero, diametro 80 mm con 2 mt. di cavo di alimentazione + 1 presa DE + 2 prese USB 5V/2, 4A + 1 presa RJ45 (intercambiabile). L'interno del coperchio è provvisto di caricatore wireless (utilizzabile solo quando aperto).



wireless recharge RJ45 DE USB 1

**Optional (on demand)\*:**  
 Opzionali (su richiesta)\*:

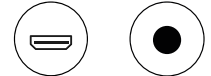

HDMI EXIT



GB IT FRA

\* dedicated quotation and minimum order  
 \* quotazione dedicata e minimo d'ordine

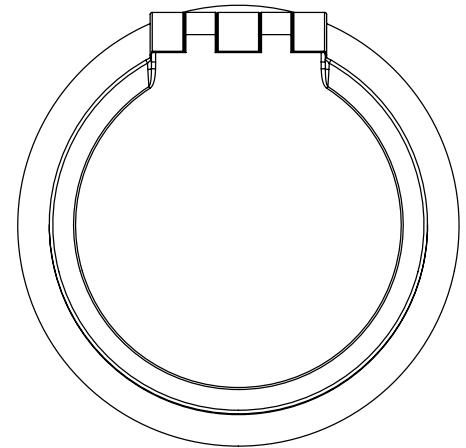
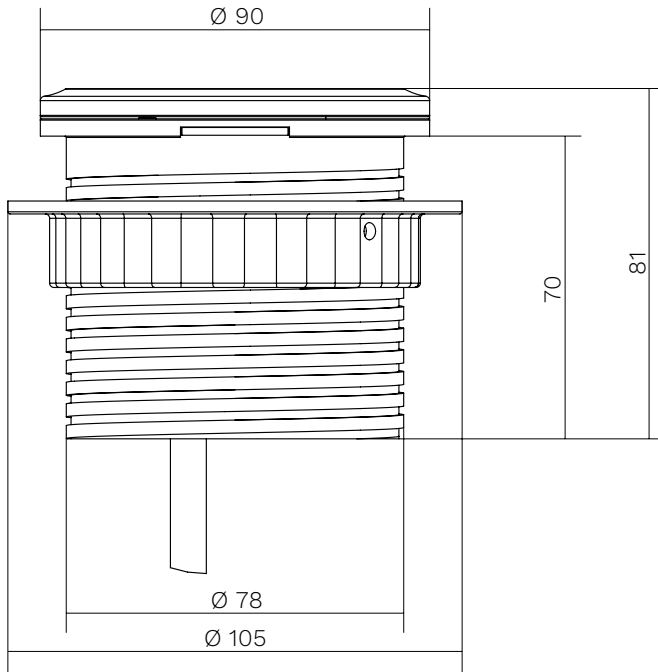

**Surface cut-out area**  
 Area di taglio della superficie

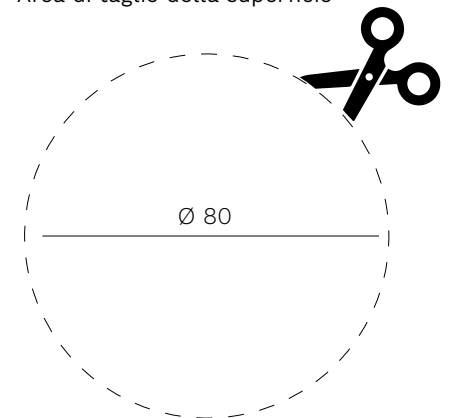

All measurements are indicated in mm  
 Tutte le misure sono indicate in mm

**COLOURS AVAILABLE / COLORI DISPONIBILI**





**en** All the energy used in our company is 100% green and comes exclusively from renewable sources.

**it** Tutta l'energia utilizzata nella nostra azienda è 100% GREEN e proviene esclusivamente da fonti rinnovabili.

**en** As it is always seeking to improve its products, the company reserves the right to modify or upgrade the products without prior notice, at any time. Colors should be considered purely indicative. Mara's Collections are worldwide protected by the industrial property right and patents.

**it** Mara, sempre alla ricerca del miglioramento dei propri prodotti, si riserva la facoltà di apportare modifiche costruttive e funzionali in qualsiasi momento senza alcun preavviso. I colori dei materiali sono da ritenersi puramente indicativi. Tutte le collezioni Mara sono protette nel mondo dal diritto di proprietà industriale e da brevetti registrati.